



FLEXICIENCY

**energy services demonstrations of demand response,
FLEXibility and energy efficiENCY based on metering data**

Deliverable D7.4

**Report on the integration of the infrastructure with the new
Services/Aggregator platforms**

V1.0



**This project has received funding from the
European Union's Horizon 2020 research and innovation programme
under grant agreement n° 646482**



D7.4 – Report on the integration of the infrastructure with the new Services/Aggregator platforms for the Spanish demo

Document Information

Program	Horizon 2020 – Cooperation / Energy
Project acronym	FLEXICIENCY
Grant agreement number	646482
Number of the Deliverable	D7.4
WP/Task related	[WP7 / T7.4]
Type (distribution level)	PU Public
Date of delivery	[12-01-2018]
Status and Version	Version 1.0
Number of pages	25 pages
Document Responsible	Giulia Vaccarone – Siemens; Andrea Zocchi – Siemens;
Author(s)	Giulia Vaccarone – Siemens; Andrea Zocchi – Siemens;
Reviewers	Gazvoda, Anton Zvonko- University of Ljubljana Friedrich Schwarzlaender-SAP

Revision History

Version	Date	Author/Reviewer	Notes
0.1	21/11/2017	Giulia Vaccarone	DRAFT
0.2	29/11/2017	Giulia Vaccarone	DRAFT
0.3	30/11/2017	Andrea Zocchi	DRAFT
0.4	05/12/2017	Giulia Vaccarone	Draft for first revision
0.5	13/12/2017	Andrea Zocchi	First release for external review
1.0	12/01/2018	Giulia Vaccarone	Final release

Notations, abbreviations and acronyms

DSO	Distribution System Operator
EB	Energy Box
EMS	Energy Management System
POD	Point of Delivery
MQTT	M2M IOT focused connectivity protocol



Executive summary

The deliverable provides the results obtained by the integration (prototyping and deployment) of different equipment (energy box, V2H, etc.) and systems with the new Service/Aggregator platform in Malaga City demo site.

This integration is carried out as part of the WP7 (Spanish demonstration).

The project has been developed in Malaga and devices have been installed in different buildings in the ownership of the Municipality:

- Medium and small building where only monitoring services have been provided.
- Tabacalera Complex represented by a group of buildings where monitoring and load control services have been provided.

EMS platform is used as backend infrastructure for both Service and Aggregator.





Table of contents

Revision History.....	3
Notations, abbreviations and acronyms.....	3
Executive summary.....	4
Table of contents.....	5
List of Figures.....	6
1. Scope of the document.....	7
2. Introduction.....	8
2.1. EMS User Interface for Small Buildings.....	8
2.1.1 Smart Info.....	9
2.2. EMS User Interface for Large Buildings.....	10
2.2.1 Building – Module 4.....	11
2.2.2 Building – Module 5.....	12
2.2.3 Microgrid.....	13
2.2.4 Smart Home showroom (V2H Home Pilot).....	13
3. Devices integration.....	14
3.1. Asset General details.....	16
3.2. Asset feeds.....	17
3.3. Asset Communication Properties.....	20
3.4. Asset diagnostic.....	20
4. Energy box integration.....	22
4.1. EMS and external algorithms platform.....	22
5. Appendix.....	24
5.1. Devices installed by typology.....	24
5.2. Devices installed by Use Cases.....	25



List of Figures

Figure 1: Small/medium building monitoring view	8
Figure 2: Malaga territory geographical view	8
Figure 3: Smart Info device.....	9
Figure 4: Tabacalera complex geographical view	10
Figure 5: Aggregation by typology for Tabacalera complex	11
Figure 6: Module 4 geographical view	12
Figure 7: Module 5 geographical view	12
Figure 8: Microgrid geographical view	13
Figure 9: Home Pilot geographical view	13
Figure 10: EMS High level integration architecture	14
Figure 11: Example of high level integration between Assets and Gateways	15
Figure 12: Smart Info Gateway	15
Figure 13: Compatible devices	16
Figure 14: Asset general details	17
Figure 15: Example of Smart Info Feeds	18
Figure 16: Example of Power Analyzer Feeds.....	18
Figure 17: Third Floor of Module 4.....	19
Figure 18: Smart Info Communication properties.....	20
Figure 19: Asset Diagnostic Status.....	20
Figure 20: Energy Box integration	22
Figure 21: Algorithm communication Time diagram.....	23
Figure 22: Rule Set for Tabacalera complex.....	23





1. Scope of the document

Deliverable D7.4 gives a detailed description of the integration and communication between the field devices deployed in Malaga and the EMS Platform.

This integration is carried out as part of the WP7 (Spanish demonstration).

Chapter 2 describes the user interface of EMS Platform for Small buildings and Large buildings.

Chapter 3 offers a technical description of the communication protocol used to integrate the devices with the EMS Platform.

Chapter 4 describes Energy Boxes integration and how external algorithms communicate with the EMS Platform.



2. Introduction

2.1. EMS User Interface for Small Buildings

Medium and small buildings are characterized by contracted power lower than 50kW.

In the Spanish Demo, 19 small buildings have been integrated in **EMS Platform**.

For each building a **Smart Info** device has been installed to monitor the energy consumption.

No flexibility or control services are performed for small buildings.

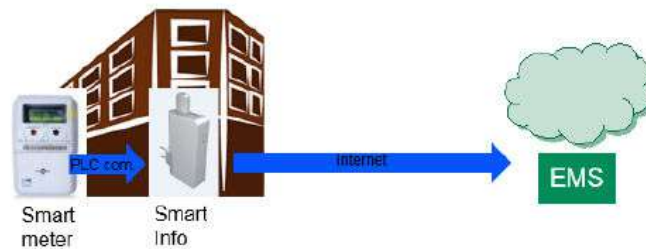

Figure 1: Small/medium building monitoring view

This scenario allows covering the following use cases:

- UC WP7_1: “Provide the customers with advanced information for awareness purpose”.
- UC WP7_2: “Provide the customers with alarms and notifications”.
- UC WP7_3: “Measurement and verifications of energy savings”.

The EMS Platform user interface shows geographical location of the buildings (ref. Figure 2) and provides the possibility to aggregate by typology, the acquired consumption meter data.

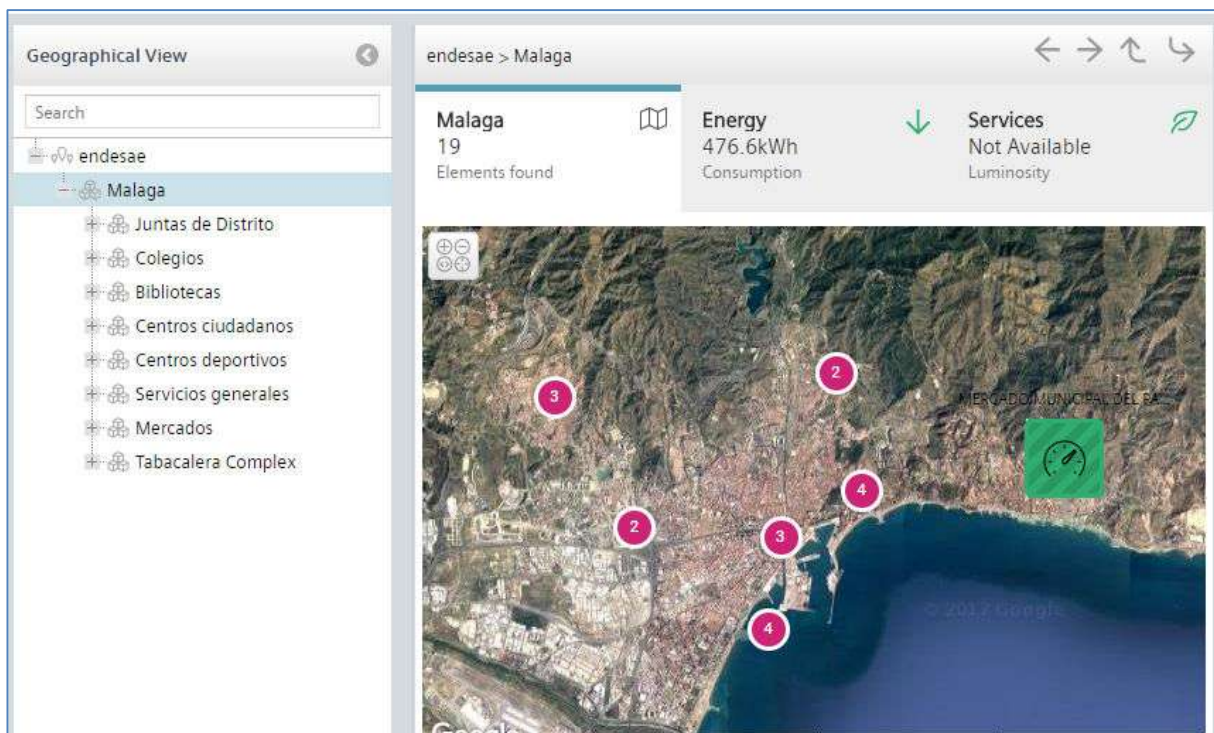

Figure 2: Malaga territory geographical view

2.1.1 Smart Info

Smart Info devices are used to provide the Municipality of Malaga awareness on energy consumption information on all the Small Buildings involved in the demo.

Smart Info is a unique device that, by communicating directly with Endesa Smart Meters, makes certified consumption and generation data at hand. It can be either plugged in any electricity socket (plug-in version) or installed in the switchboard (DIN version) and is immediately active.



Figure 3: Smart Info device

The Smart Info is the bottom ring of the Endesa Smart Metering System. Each device is coupled with the customer's smart meter. The low voltage concentrator in the secondary substation oversees the data transfer from the meter to the Smart Info, which in turn can request data update when needed. Communication is via power line in the A Band reserved to the electricity utility. Smart Info has 2 USB ports for wired connection or to connect wireless communication dongles.

All the Smart Info installed at Municipality small buildings use a 3G dongle modem to communicate with EMS Platform.



2.2. EMS User Interface for Large Buildings

Large buildings are characterized by contracted power greater than 50kW.

In the Spanish Demo, Tabacalera complex has been chosen as a representative of a large building for the experimentation. This complex includes two main buildings (Module 4 and Module 5), a Microgrid and a Smart Home showroom.

Power Analyzers, Sensors, a Solar Generator, a Storage/Inverter, smart plugs and controllers are different kinds of **devices** that have been installed at Tabacalera complex and integrated with **EMS Platform**.

This scenario allows covering the following use cases:

- UC WP7_1: “Provide the customers with advanced information for awareness purpose”.
- UC WP7_2: “Provide the customers with alarms and notifications”.
- UC WP7_3: “Measurement and verifications of energy savings”.
- UC WP7_4: “Management and optimization of simple loads to improve the energy efficiency”.
- UC WP7_5: “Management and optimization of photovoltaic and storage system”.
- UC WP7_6: “Optimization of a micro-grid with photovoltaic and V2G”
- UC WP7_7: “Optimization of DSO network operation using Flexibility Services”.

The EMS Platform shows the geographical location of the Tabacalera context with its devices (ref. Figure 4) and provides the possibility to aggregate the acquired consumption data by geographical location (Module 4, Module 5...) or by typology (ref. Figure 5).

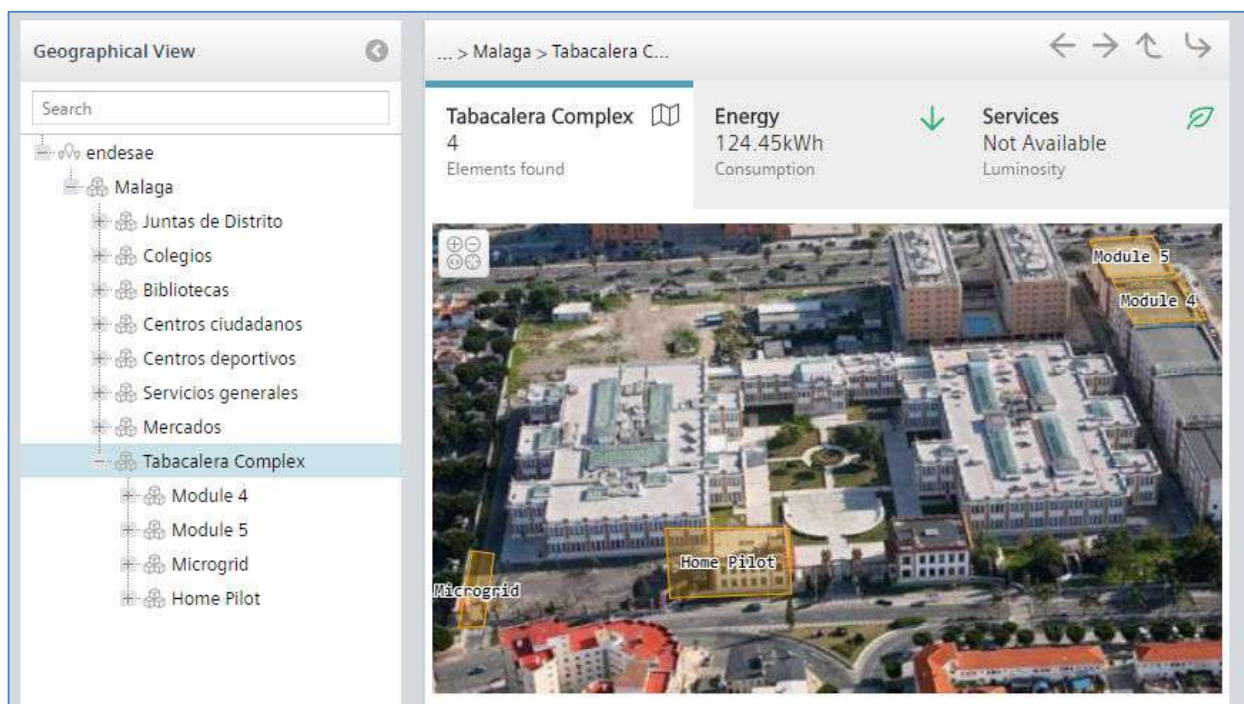

Figure 4: Tabacalera complex geographical view

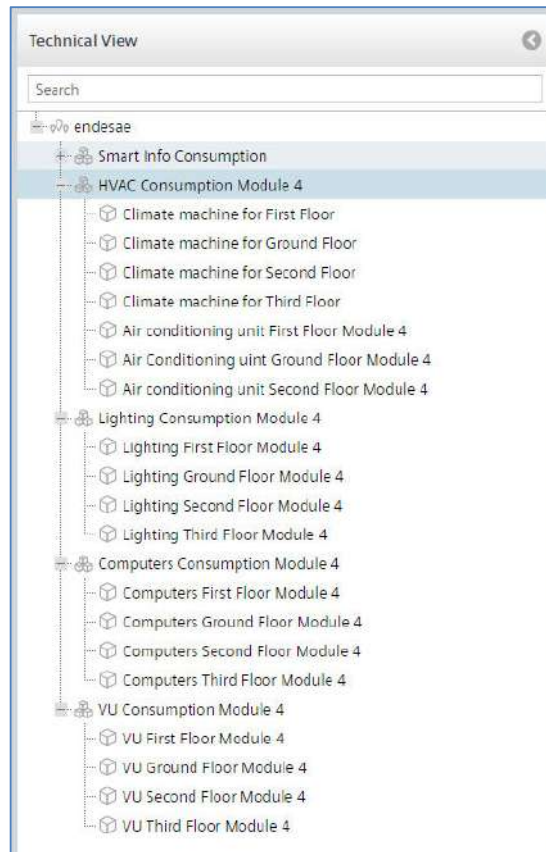

Figure 5: Aggregation by typology for Tabacalera complex

2.2.1 Building – Module 4

A set of power analyzers has been installed for monitoring different kinds of energy consumption. In the third floor of this building also a set of sensors and controllers has been installed. They are represented by:

- 14 Presence sensors
- 8 Door/Windows sensors
- 2 Smart Plug
- 2 HVAC controllers.

Power analyzers, sensors and controllers have been integrated with EMS Platform (ref. Figure 6) and the consumption data have been aggregated not only by physical division (floor 1, 2, 3) but also by type of the use.

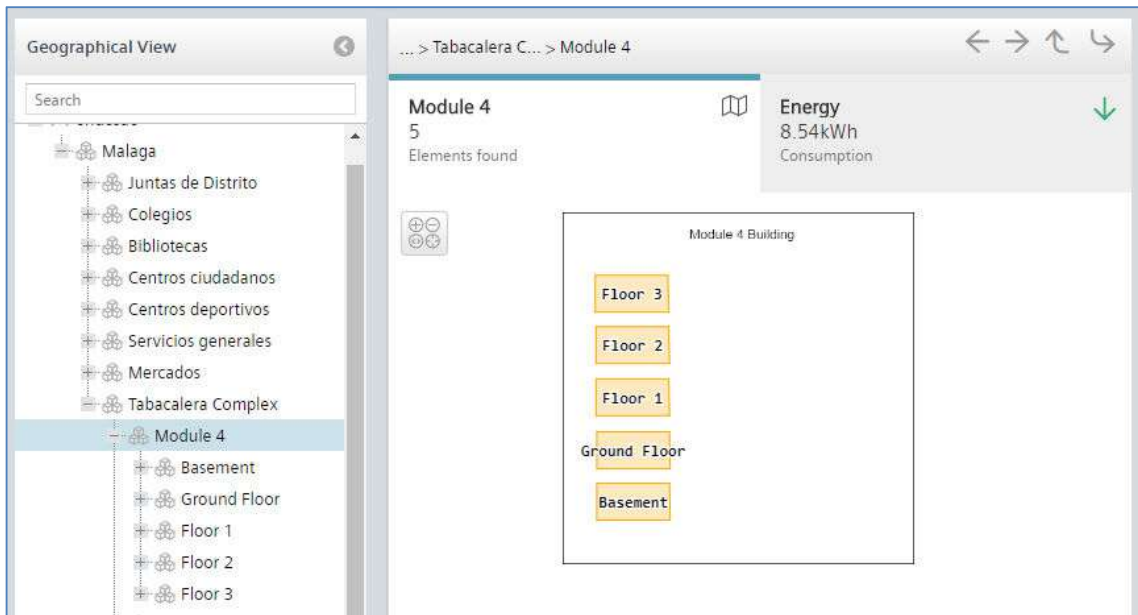

Figure 6: Module 4 geographical view

2.2.2 Building – Module 5

A small set of power analyzers has been installed in building Module 5. These devices have been integrated with EMS Platform and only monitoring has been offered.

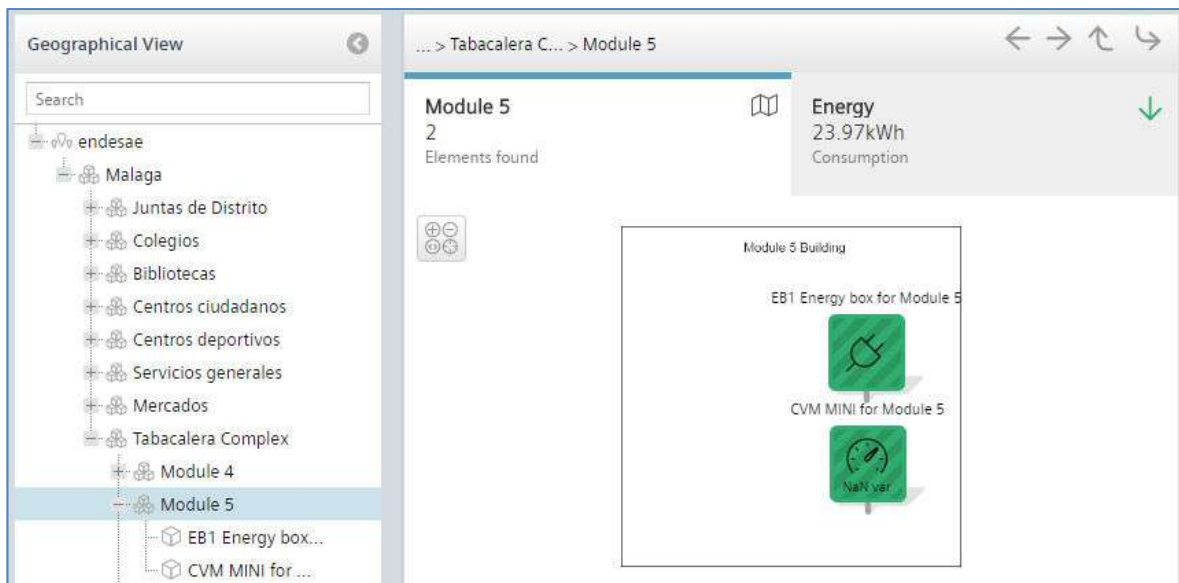

Figure 7: Module 5 geographical view

2.2.3 Microgrid

Microgrid is an area where Power Analyzers, a Solar Generator and Storage/Inverter devices have been installed and then integrated with EMS Platform (ref. Figure 8).

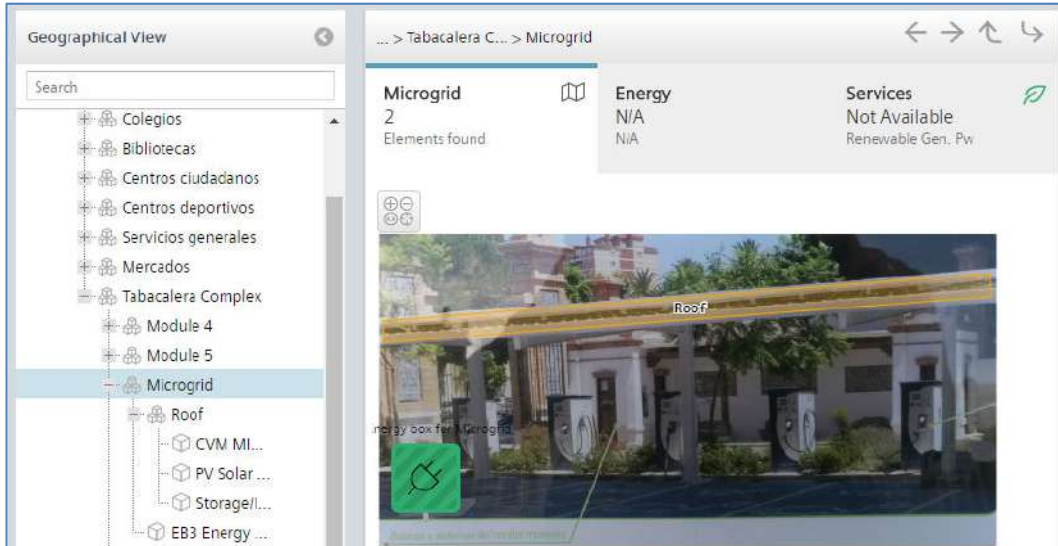

Figure 8: Microgrid geographical view

2.2.4 Smart Home showroom (V2H Home Pilot)

The Smart Home showroom is an area at Tabacalera complex where a set of analyzers, sensors and controllers have been installed. All these devices have been integrated in EMS Platform (ref. Figure 9). In this case the main activities implemented are the monitoring of the energy consumption of the V2H Home Pilot and the managing of the devices to achieve a reduction in overall consumption.

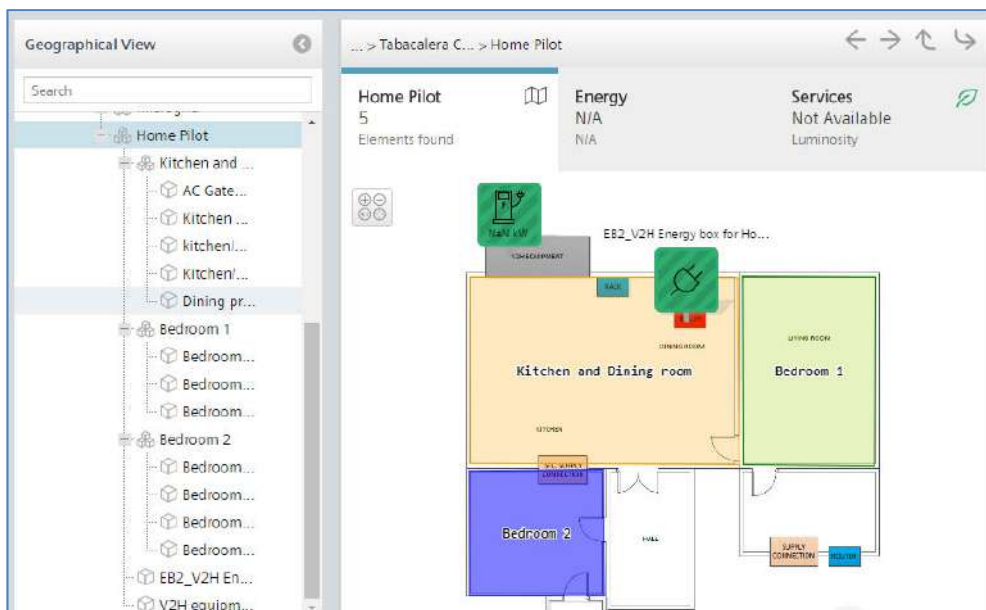

Figure 9: Home Pilot geographical view

3. Devices integration

Different kinds of devices have been installed for the Spanish demo.

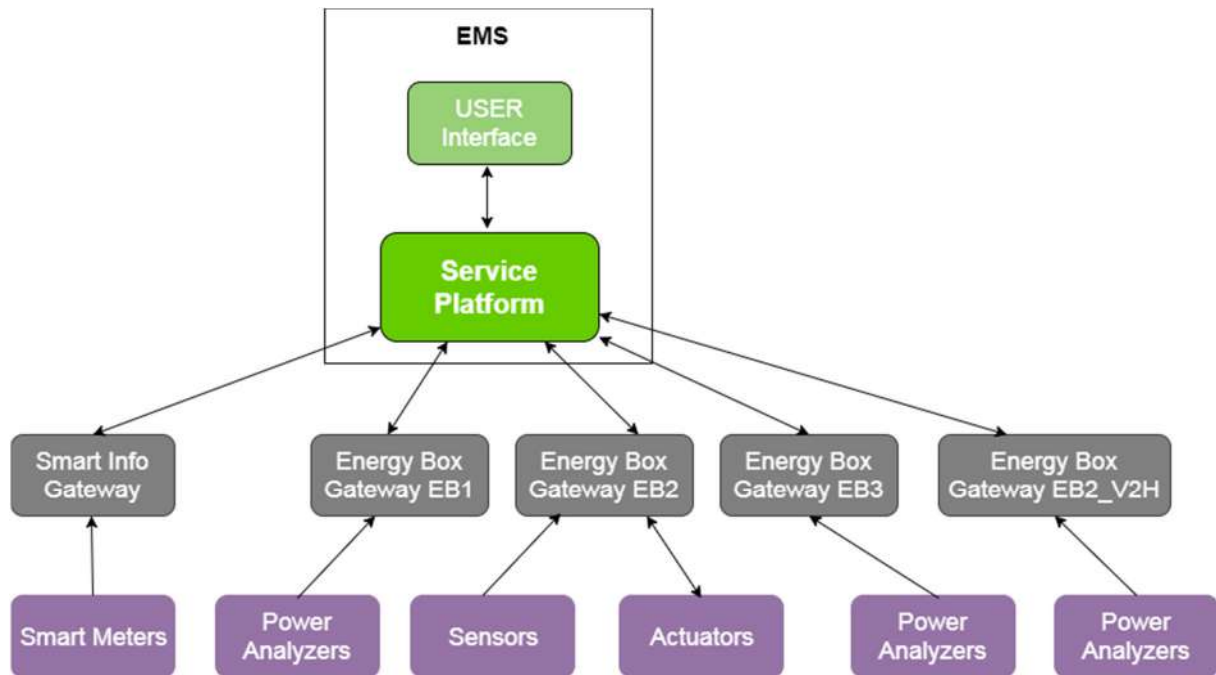

Figure 10: EMS High level integration architecture

In this context, **ASSETS** are the synonym of the DEVICES.

In the EMS Platform, an asset (e.g. gray boxes in Figure 10) is characterized by:

- **General details** (ref. paragraph 3.1)
- **Feeds** (ref. paragraph 3.2)
- **Communication Properties** (ref. paragraph 3.3)
- **Diagnostics** (ref. paragraph 3.4)

Assets on premise communicate with EMS Platform through the dedicated Gateways (ref. Figure 11).

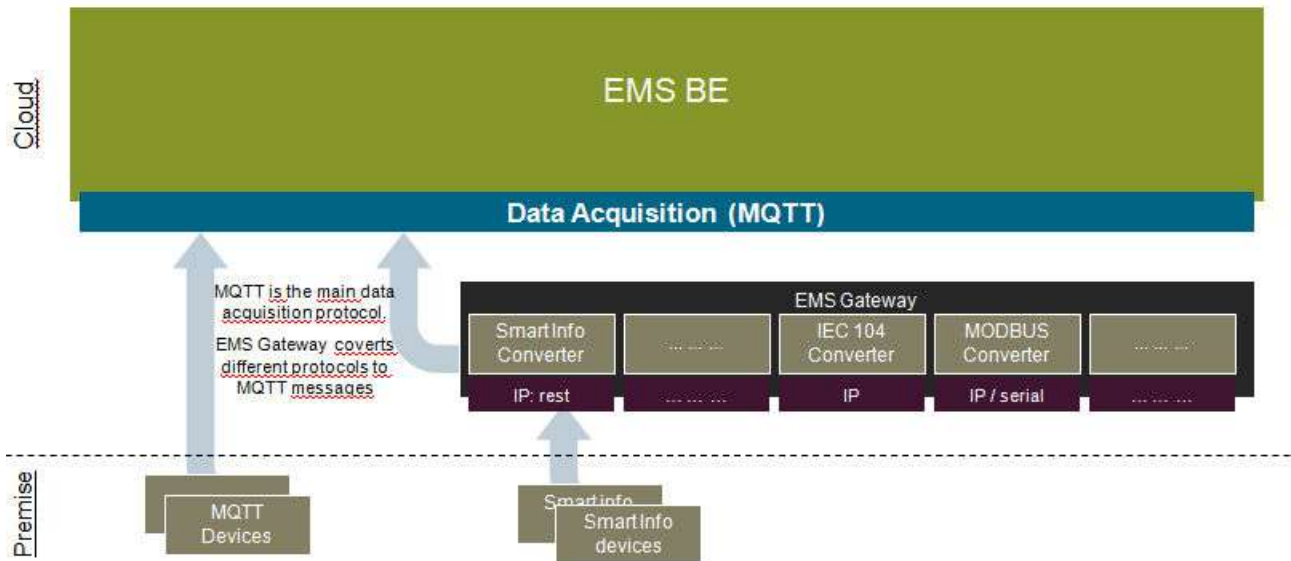

Figure 11: Example of high level integration between Assets and Gateways

For Small buildings, 19 PODs in Malaga city have been monitored using Smart Info kits. Each Smart Info is the physical device directly connected to a Smart Info Gateway by a specific communication protocol.

The Smart Info Gateway communicates with the EMS Platform (ref. Figure 12) via MQTT protocol.

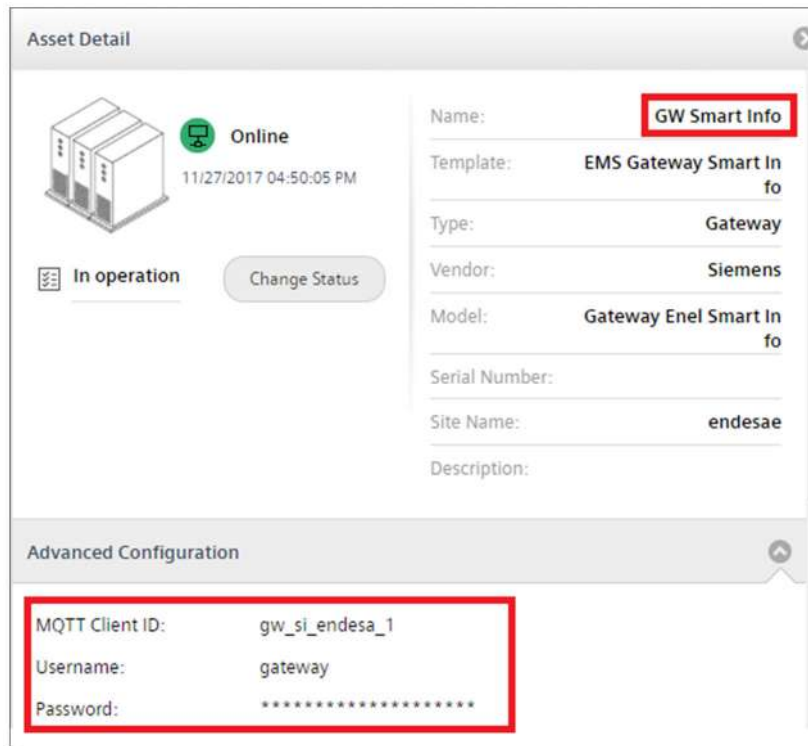
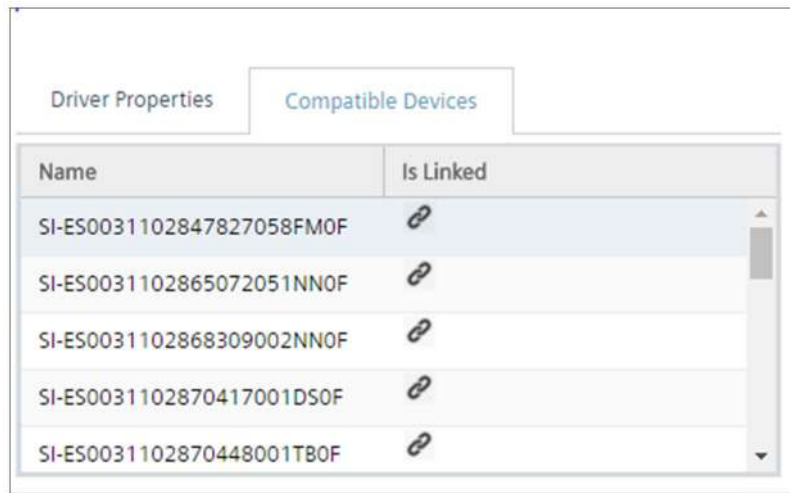

Figure 12: Smart Info Gateway

All Smart Info devices have been linked to the Smart Info Gateway (ref. Figure 13).







Name	Is Linked
SI-ES0031102847827058FM0F	
SI-ES0031102865072051NN0F	
SI-ES0031102868309002NN0F	
SI-ES0031102870417001DS0F	
SI-ES0031102870448001TB0F	

Figure 13: Compatible devices

For the large buildings, a set of power analyzers and sensors have been deployed and integrated. To communicate with EMS Platform these devices are directly connected to dedicate MQTT Gateways. These gateways are represented by **Energy Box** devices installed at Tabacalera complex.

From a technical point of view, MQTT Gateways and Smart Info Gateway communicate via MQTT with the EMS MQTT Broker. All of them need a basic configuration to start:

- the URL of EMS MQTT Broker,
- the unique MQTT ClientId,
- username and password.

3.1. Asset General details

Each asset contains “General Details” section where parameters like:

- Name,
- Vendor,
- Type,
- Description

can be defined (ref.Figure 14).



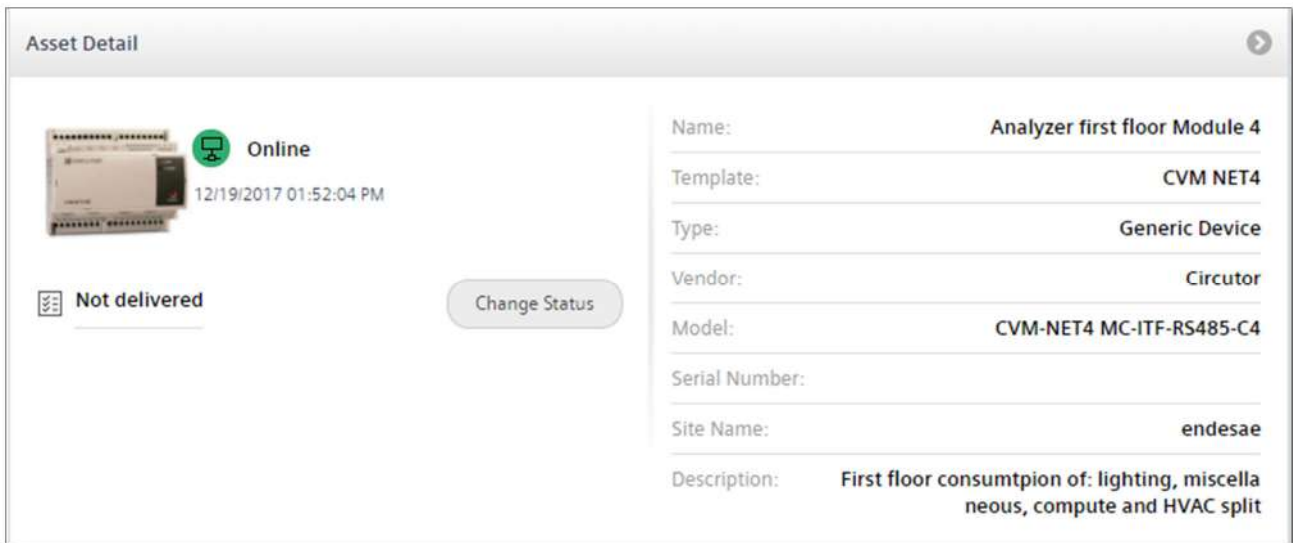

Figure 14: Asset general details

3.2. Asset feeds

Feeds represent the registers to which assets publish data acquired from the field. Each asset has more than one feed to perform the communication. Each feed is characterized by a specific address.

From a technical point of view, the communication protocol is based on particular string called topics. The topic syntax used to send and/or to receive data from field is the following:

- base Topic: **de/<deviceld>**
- from the field:
 - COV publish from gateway: **de/<deviceld>/<address>**
- write to the field:
 - publish: **de/<deviceld>/write/<address>**
 - subscribe to: **de/<deviceld>/write/+**

By expanding the feed section in the EMS platform, it is possible to monitor, for each integrated asset, if the corresponding device is gathering data (ref. Figure 15 and Figure 16).

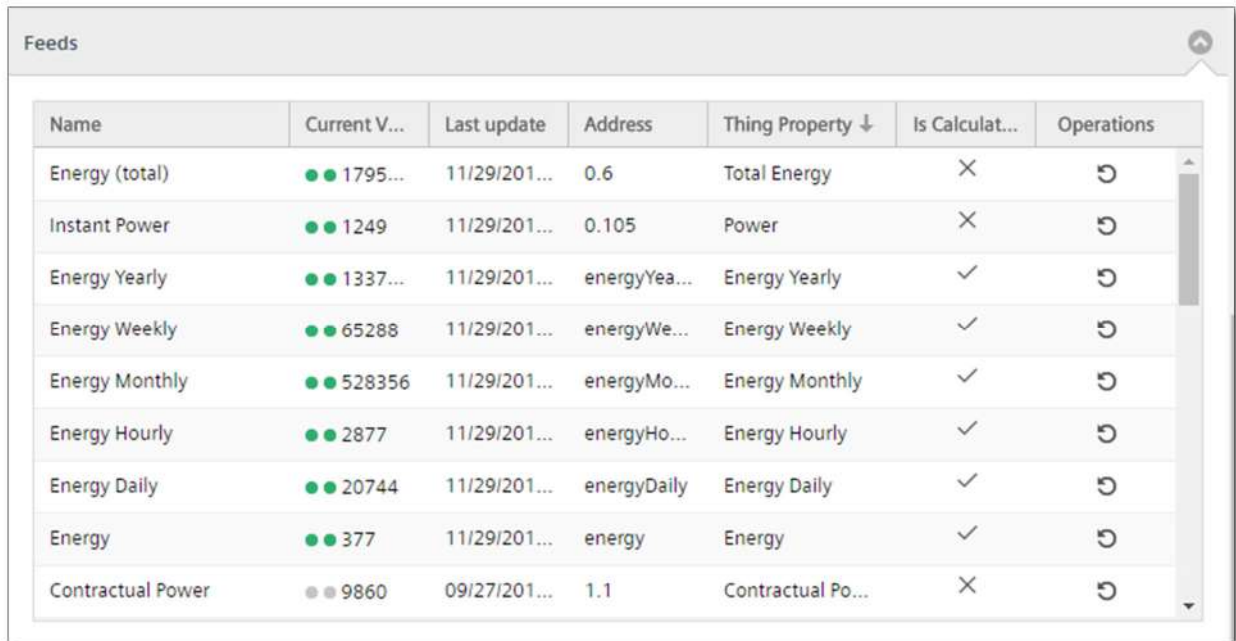

Name	Current V...	Last update	Address	Thing Property ↓	Is Calculat...	Operations
Energy (total)	●● 1795...	11/29/201...	0.6	Total Energy	×	↻
Instant Power	●● 1249	11/29/201...	0.105	Power	×	↻
Energy Yearly	●● 1337...	11/29/201...	energyYea...	Energy Yearly	✓	↻
Energy Weekly	●● 65288	11/29/201...	energyWe...	Energy Weekly	✓	↻
Energy Monthly	●● 528356	11/29/201...	energyMo...	Energy Monthly	✓	↻
Energy Hourly	●● 2877	11/29/201...	energyHo...	Energy Hourly	✓	↻
Energy Daily	●● 20744	11/29/201...	energyDaily	Energy Daily	✓	↻
Energy	●● 377	11/29/201...	energy	Energy	✓	↻
Contractual Power	●● 9860	09/27/201...	1.1	Contractual Po...	×	↻

Figure 15: Example of Smart Info Feeds

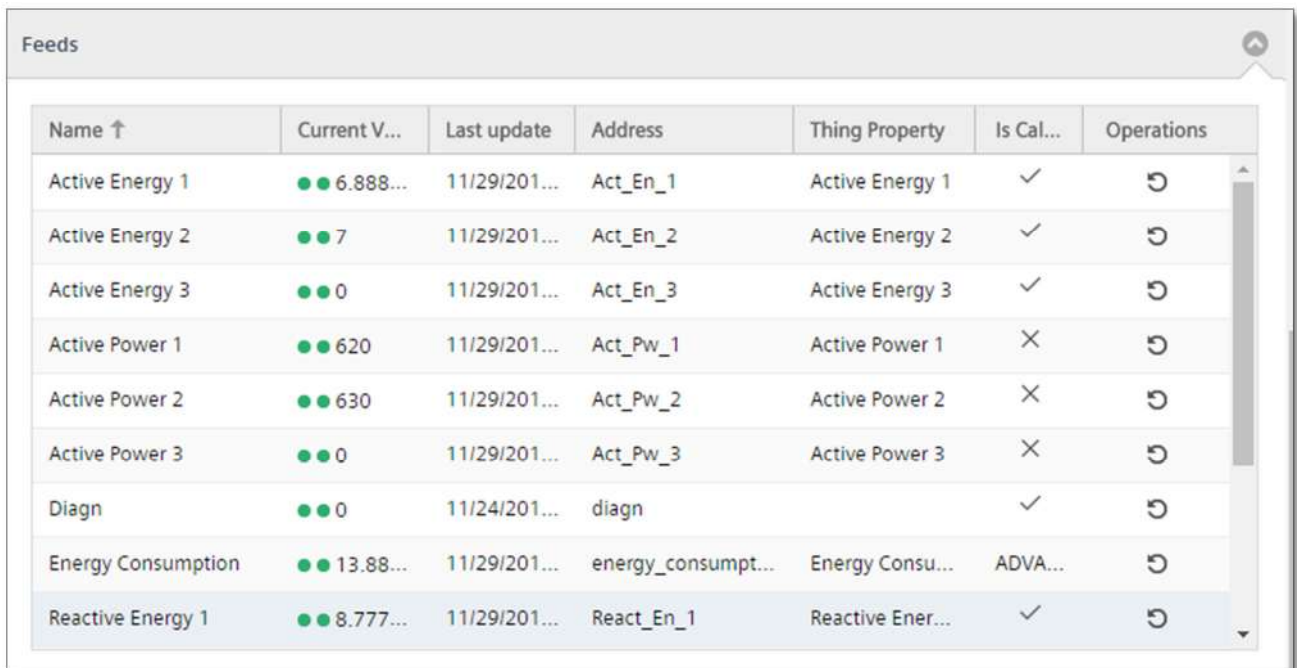

Name ↑	Current V...	Last update	Address	Thing Property	Is Cal...	Operations
Active Energy 1	●● 6.888...	11/29/201...	Act_En_1	Active Energy 1	✓	↻
Active Energy 2	●● 7	11/29/201...	Act_En_2	Active Energy 2	✓	↻
Active Energy 3	●● 0	11/29/201...	Act_En_3	Active Energy 3	✓	↻
Active Power 1	●● 620	11/29/201...	Act_Pw_1	Active Power 1	×	↻
Active Power 2	●● 630	11/29/201...	Act_Pw_2	Active Power 2	×	↻
Active Power 3	●● 0	11/29/201...	Act_Pw_3	Active Power 3	×	↻
Diagn	●● 0	11/24/201...	diagn		✓	↻
Energy Consumption	●● 13.88...	11/29/201...	energy_consumpt...	Energy Consu...	ADVA...	↻
Reactive Energy 1	●● 8.777...	11/29/201...	React_En_1	Reactive Ener...	✓	↻

Figure 16: Example of Power Analyzer Feeds

In case of Power analyzer, different kinds of data are provided: 3 phases Active Power, 3 phases Reactive Power and the related Energy (calculated by EMS platform). The 3 phases Active Energy are summed together to contribute to the total consumption of the monitored point.



Also, different kinds of sensors and controllers have been deployed in Tabacalera complex. Particularly in the third floor of the Module 4, there are 14 presence sensors, 8 door/window sensors, 2 smart plugs and 2 climate controllers (ref. Figure 17). For all of them, different types of data are provided: temperature values, IAS zone values, and lighting values.

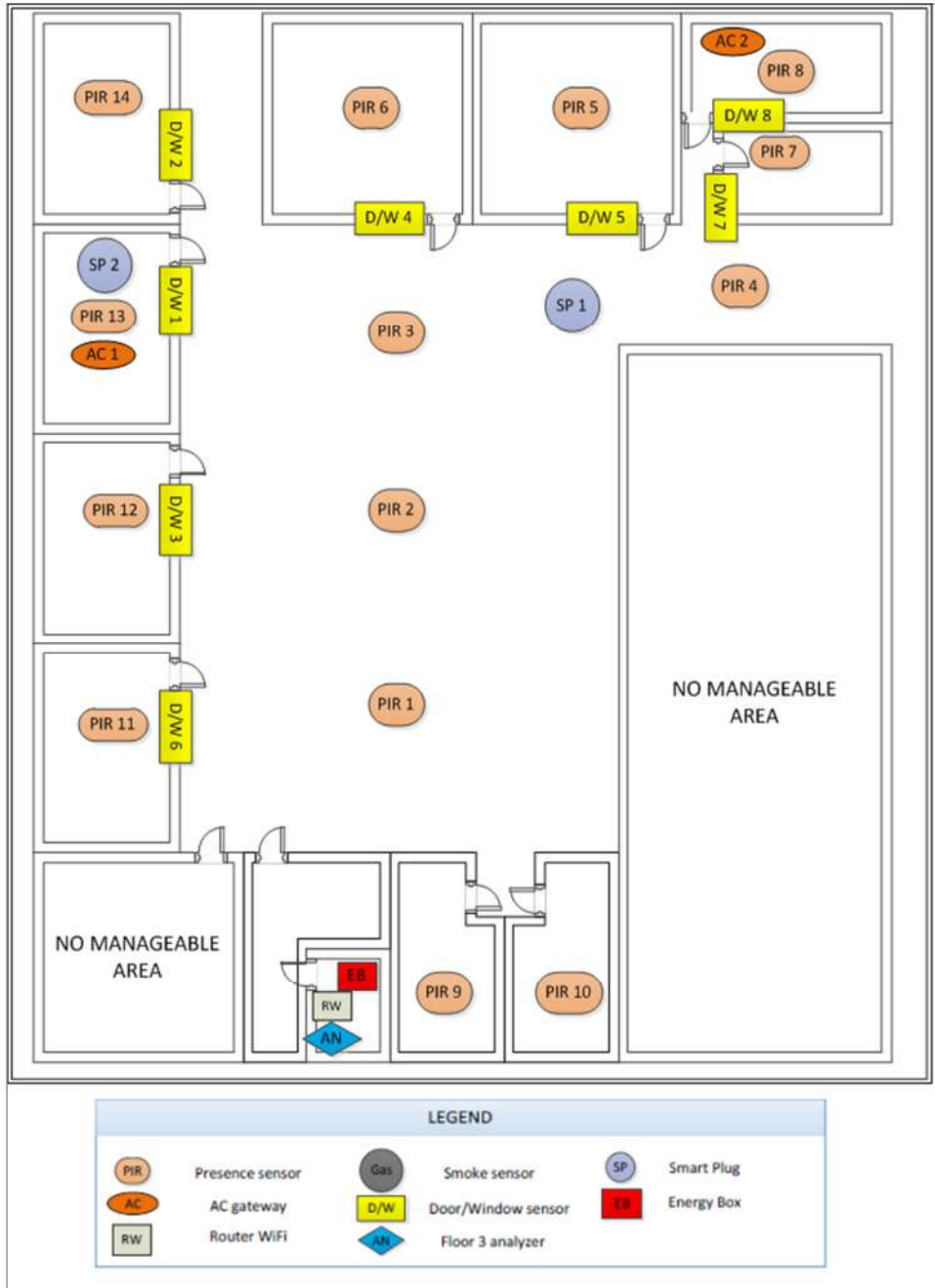
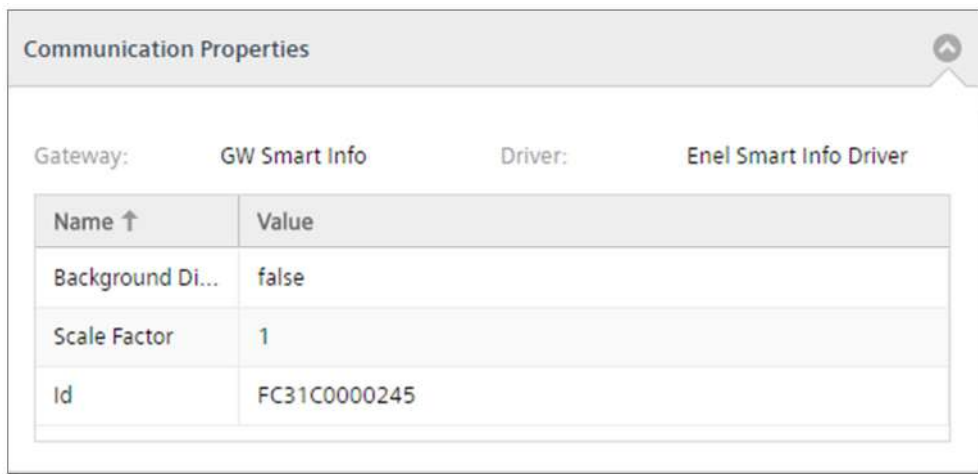

Figure 17: Third Floor of Module 4

3.3. Asset Communication Properties

The Communication Properties section specifies how an asset can communicate with the dedicated Gateway. The correct configuration of these parameters, guarantees the communication between the devices and the EMS Platform.

In the case of the Smart Info (small buildings) it is necessary to specify the gateway, the related driver and the unique Identifier ID (ref. Figure 18).



Name ↑	Value
Background Di...	false
Scale Factor	1
Id	FC31C0000245

Figure 18: Smart Info Communication properties

3.4. Asset diagnostic

Gateways and assets manage communication, including diagnostic between them. In particular assets use the Diagnostic Feed to send diagnostic information (ref. Figure 19).

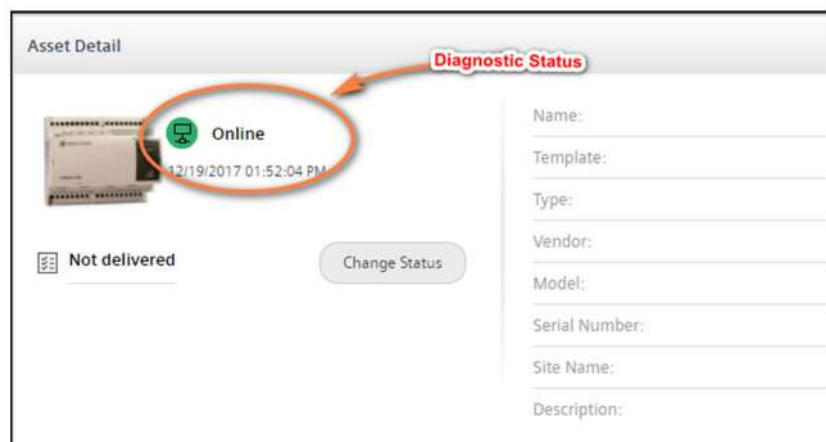

Figure 19: Asset Diagnostic Status



From a technical point of view, the topic used to send diagnostic data is the following:

- **de/<deviceId>/diagn**

It can assume one of the following values:

- **DIAGN_STATUS_UNLINKED** (DEVICE), the device is not linked to any GATEWAY; it is the Assets Service that can link/unlink Devices.
- **DIAGN_STATUS_UNKNOWN** (ALL), the diagnostic state is unknown; typically because its parent is offline.
- **DIAGN_STATUS_OFFLINE** (ALL), disconnected.
- **DIAGN_STATUS_ONLINE** (ALL), connected and working.
- **DIAGN_STATUS_ERROR** (ALL), error - same as disconnected but due to an error.
- **DIAGN_STATUS_ONLINE_ANOMALY** (GATEWAY), connected but there are issues.

All of the above values represent the status of the connection between the devices and the EMS Platform.



4. Energy box integration

In Tabacalera complex, five Energy Box devices have been installed. Each of them communicates with a set of sensors and analyzers located in different area of the buildings.

All the data acquired by the EMS Platform from sensors and analyzers is processed by Circe algorithms platform and then sent to the related Energy Box.

4.1. EMS and external algorithms platform

The EMS Platform receives data from the different devices installed. All of these measures and a list of static parameter (specific for each device) are sent to the Circe algorithms platform which elaborates all the information received and sends the results to the EMS. Results received by the EMS Platform are then transmitted to each Energy Box.

All command messages propagated to the various controllers (sensors, plugs...) are sent directly from the Energy Box.

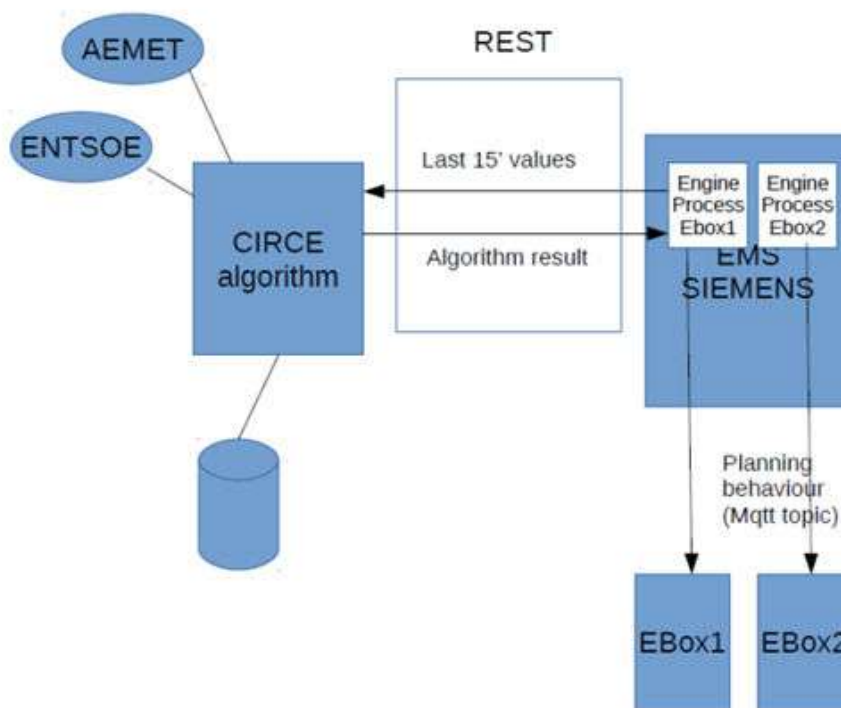

Figure 20: Energy Box integration

The communication between EMS Platform and CIRCE algorithms platform is provided by the Engine Module of EMS platform.

From a technical point of view, the EMS Engine Module collects all the information about distinct devices belonging to each Energy Boxes and sends all the data using the HTTP POST request to



the CIRCE algorithm. Circe Optimizer receives the request form EMS Platform and creates the response with a planned action for each Energy Box.

The HTTP response is received by Engine Module and sent to the corresponding Energy Boxes (ref. Figure 21).

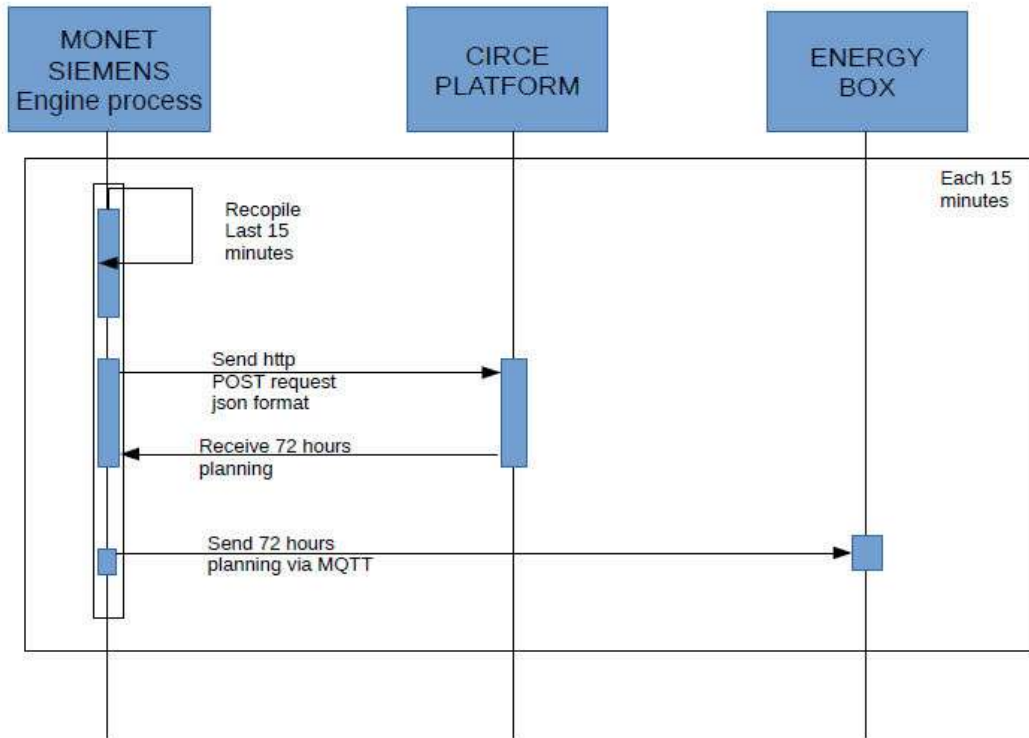

Figure 21: Algorithm communication Time diagram

The EMS Engine module has been configured using a specific Rule that includes the algorithm to handle the illustrated time diagram (ref. Figure 21). This Rule has been included in a Rule Set activated for the Tabacalera complex. Every 15 minutes, the EMS Engine module sends the input variable data to the Circe algorithms platform and handles the response flow.

The input data has been aggregated by Tag. A Tag (concept similar to tags used in social media) is a specific label attached for the purpose of facilitating the identification of input elements for the algorithm . Tags are an easily way to cluster together the devices belonging to each Energy Boxes.

Rules			
Active	Rule name	Rule type	Tags
✓	Energy boxes integration algorithm	Base	EnergyBox1, EnergyBox Module 4, EnergyBox Module 5, EnergyBox 2 Module 4, EnergyBox Microgrid, EnergyBox for Showroom

Figure 22: Rule Set for Tabacalera complex



5. Appendix

5.1. Devices installed by typology

Devices installed at Tabacalera complex:

- 3 x CVM-NET4 MC-ITF-RS485-C4
- 1 x CVM-C10-ITF-485-ICT2
- 1 x CVM-NET MC-ITF-RS485-C2
- 1 x CVM-MINI-ITF-ETH-C2
- 10 x SENNET
- 32 x DEVELCO
 - 2 x Smart Plug,
 - 11 x Door/Window sensor,
 - 19 x Presence sensor
- 3 x INTESIS
- 3 x CLEODE
- 1 x WEBBOX
- 1 x V2H EQUIPMENT

Devices installed in the territory of Municipality of Malaga:

- 19 x Smart Info





5.2. Devices installed by Use Cases

Use Case WP7 1 / WP7 2 / WP7 3

List of devices installed in the small buildings and Module 4 and 5 at Tabacalera Complex:

- 3 x CVM-NET4 MC-ITF-RS485-C4
- 1 x CVM-C10-ITF-485-ICT2
- 1 x CVM-NET MC-ITF-RS485-C2
- 6 x SENNET
- 19 x Smart Info

Use Case WP7 4

List of devices installed in Third Floor of Module 4 at Tabacalera Complex:

- 4 x SENNET
- 24 x DEVELCO
 - 2 x Smart Plug,
 - 8 x Door/Window sensor,
 - 14 x Presence sensor
- 2 x INTESIS

Use Case WP7 5

List of devices installed in the Microgrid at Tabacalera Complex:

- 1 x CVM-MINI-ITF-ETH-C2
- 1 x WEBBOX

Use Case WP7 6

List of devices installed in the EM showroom at Tabacalera Complex:

- 3 x DEVELCO
 - 3 x Door/Window sensor,
 - 5 x Presence sensor
- 1 x INTESIS
- 3 x CLEODE
- 1 x V2H EQUIPMENT